



ALUKON

Sonnenschutz Rollladen Insektenschutz

VENETIAN BLIND SYSTEMS

RAFF-E, FACADE VENETIAN BLINDS, BUILT-ON AND WINDOW FRAME
MOUNTED VENETIAN BLINDS

WWW.ALUKON.COM

ALUKON
Sonnenschutz Rollläden Insektenschutz

VENETIAN BLINDS BY ALUKON

LIGHT REGULATION AND VISUAL PROTECTION

ALUKON venetian blinds are a modern sun protection, aesthetically integrated into the facade design and giving a warm, cosy lighting effect to your living room.

Enjoy the non-glaring daylight and make your individual settings for incoming light. Due to the reflexion of the sun light, venetian blinds are creating a convenient indoor climate saving costs for air condition and satisfy the demand for privacy through visual protection and the right level of transparency.

**Other products and novelties are to be found on
WWW.ALUKON.COM**



MORE THAN JUST VISUAL PROTECTION AND SUNSCREEN

ALUKON SYSTEMS HAVE MORE ADVANTAGES THAN YOU MIGHT IMAGINE



Sun protection

convenient indoor climate on hot summer days



For large surfaces

up to 16 m², max width 500 cm



Anti-glare protection

flexibly adjustable aluminium slats



Insect repelling system

for many box types, will keep your home free of annoying insects



Visual protection

more privacy at home



Facade design

venetian blinds as part of a fancy facade look



Saving energy

due to reflection of sunlight



Ease of use

comfortable operation with motor or remote control and easy operation with crank drive



Extruded or roll formed

built-on boxes from strong, extruded aluminium; RAFF-E and facade venetian blinds from solid, bevelled aluminium



Made in Germany

durable, high-quality materials



LIGHT GUIDANCE WITH DESIGN

STYLISH, FLEXIBLE SUN PROTECTION

ALUKON venetian blinds help to control and regulate the light levels of incoming daylight in your home to get a comfortable indoor ambience. They help flexibly to protect your privacy and avoid glaring sunlight.





PROTECTION AND COMFORT

FOR THE HIGHEST DEMANDS

ALUKON sun protection products
can be adapted to individual needs.
Whether you need sun, privacy or insect protection –
we have the right solution for
all situations and living requirements.



RAFF-E

VENETIAN BLINDS BOX SYSTEM



PLASTERED BOX



*BOX OPEN AT
THE BACK*



*BOX CLOSED,
FRONT ACCESS*

DESIGN WITH FUNCTIONALITY

QUICK AND EASY INSTALLATION

RAFF-E is qualified for large surface areas and different types of installation. RAFF-E was created to guarantee easy measurements and installation at site. There is no need for extensive expert knowledge and the time needed at site is dramatically reduced.



Quick and easy installation

preassembled ready- to-install solution, just fix the guide rails onto the box



Roll formed and durable

our aluminium boxes are extra robust and durable



For large surfaces

max width 400 cm
max height 450 cm



Insect repelling system

available with integrated insect repelling system



FACADE VENETIAN BLINDS



*L-BLIND
PLASTERED*



*U-BLIND
PLASTERED*



*L-BLIND
VISIBLE*



*U-BLIND
VISIBLE*

NEW BUILDINGS AND MODERNISATION

IDEAL SOLUTION FOR LARGE WINDOWS

ALUKON facade venetian blinds are available as visible or shaft installation systems, with guide channels or cable guided. Installation is possible in the lintel, on the wall or on the facade with spacers.

The bevelled aluminium boxes are available in all RAL colours of the ALUKON colour variety. Besides the visible box we offer plastered versions, to be integrated almost invisibly into the facade.



For large surfaces

up to 16 m², max width 500 cm



Bevelled and durable

our aluminium boxes are extra robust and durable



Setting creative accents

available in all RAL colours in brilliant, mat or structured coating

BUILT-ON VENETIAN BLINDS



ROUND



20° BEVELLED,
BOTTOM ACCESS



20° BEVELLED,
FRONT ACCESS



45° BEVELLED



90° RECTANGULAR

A WIDE RANGE OF BOXES

SUITABLE FOR ALL ALUKON BUILT-ON SYSTEMS

Built-on boxes are available in several shapes and colours allowing an individual facade design of the building.

Combining venetian blinds with roller shutters or textile sun protection ZipTex on your facade offers the possibility to adapt the screens to your needs.



Setting creative accents

available in all RAL-colours in brilliant, mat and structured surface or anodized



Extruded and durable

our aluminium boxes are available in a wide range of different shapes, they are extra robust and non-corroding



Easy access

the exterior access blind guarantees quick and clean service and repair work



Insect repelling system

can be integrated in all built-on boxes



WINDOW FRAME MOUNTED VENETIAN BLINDS

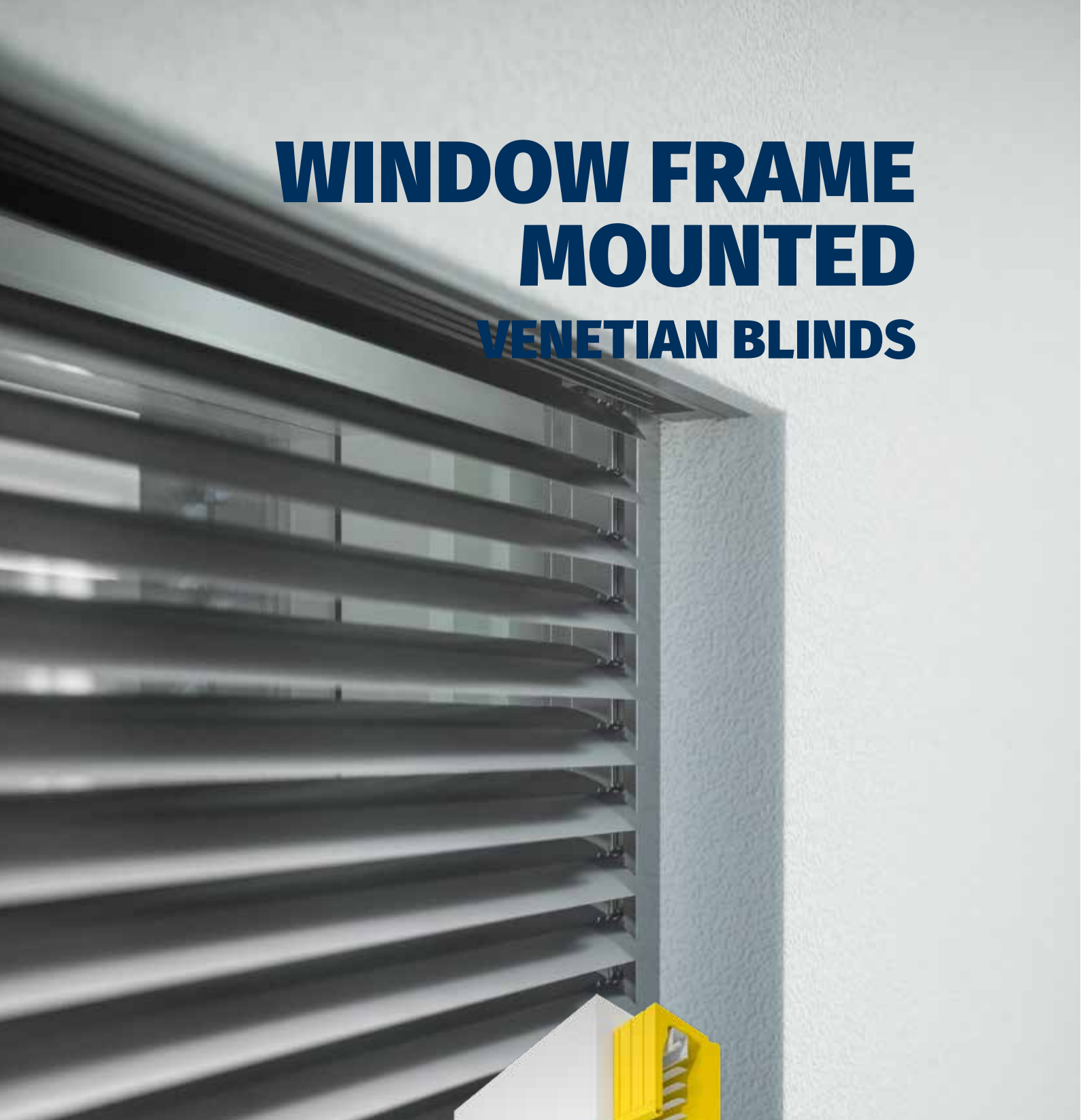

*PVC TOP-MOUNTED BOX
AK-MIRO PLUS*



*FOAMED TOP-MOUNTED
BOXES AK-FLEX.2 WITH
CLINKER*



*FOAMED TOP-MOUNTED BOX
AK-FLEX.2*

TWO IN ONE – INTEGRATED INSTALLATION

FOAMED OR PVC WINDOW FRAME MOUNTED BOX

The **foamed top-mounted box AK-FLEX.2** with venetian blind is specially designed for new buildings or renovations together with the entire window and meets the current requirements for both thermal and sound insulation. Thanks to its flexibility in outside dimensions, it can be used in all wall structures and installation situations, regardless of whether it is a thermal insulation composite system, exterior plaster, clinker or slate facade.

The **AK-MIRO PLUS top-mounted PVC box** with venetian blind is also suitable for renovation and new construction and is snapped directly onto the window for easy installation and installed together. It is compatible with all standard window types thanks to different adapter profiles that are adapted to the window system.



The invisible solution

window frame mounted boxes with venetian blinds are integrated almost invisibly into the facade



For all types of installation situations

different wall thicknesses for thermal insulation composite system, external plaster, clinker brick or slate facade



Easy installation

the box will be fixed on the window via adapter profile for integrated installation



Insect repelling systems

to be integrated into all front mounted boxes



F 80

FLAT SLATS

C/CV 80

FLANGED SLATS

THE ALUKON SLAT PROGRAMME

TAILORED TO YOUR NEEDS

External venetian blinds are all-rounders in the field of sun and privacy protection. They illuminate the room in particularly soft, glare-free light and allow a sufficient view to the outside, while conversely they maintain privacy from outside.

The slats in front of the window provide good heat protection in summer and can also increase the solar energy and daylight level in the room in winter when the sun is shining. They can be continuously controlled and adapted to the respective situation, right up to blackout with privacy function from outside to inside. In order to cope with weather conditions such as strong sunlight, wind and weather, the ALUKON venetian blind slats are made of particularly high-quality, corrosion-resistant aluminium. In order to meet the different requirements, we have four different slat shapes in our product range.

F 80 slats

space-saving, light and beautifully shaped design with low stack height



C/CV 80 flanged slats

flanging on both sides makes the slat more stable, in offset stacking CV 80 requires less space than with standard stacking of the C 80 slat

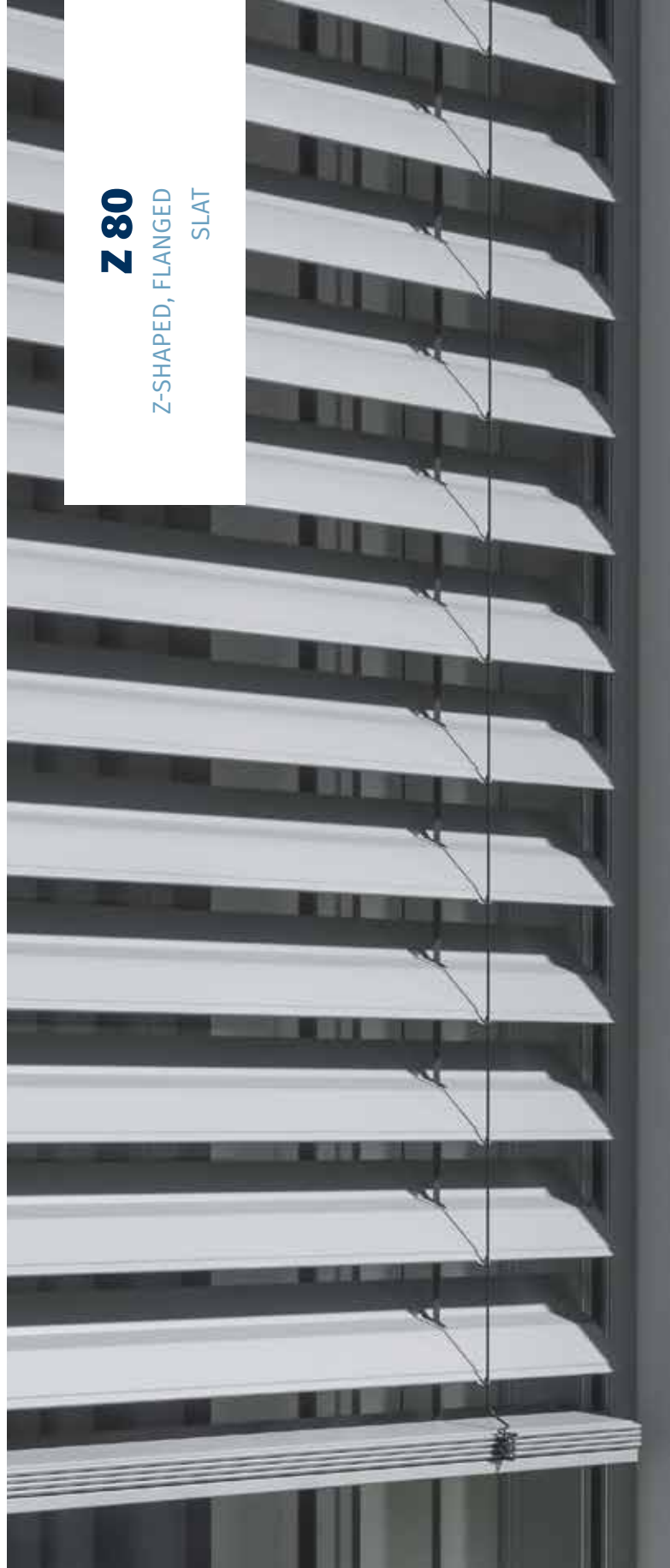

Z 80Z-SHAPED, FLANGED
SLAT**Z 80 slats**

stable z-shaped slat contour with flanging on both sides and piping on the underside for noise reduction and better closing action, suitable for darkening

**LS 80**LIGHT GUIDING
SLATS**LS 80 light guiding slats**

particularly designed slat contour for optimal light control at all times of day and year, fitted with sealing piping in the lower flanging and therefore sound-absorbing and well suited for darkening



A modern two-story house with a balcony and a pond in the foreground. The house features a mix of white and dark grey exterior panels, large windows with horizontal blinds, and a balcony with a glass railing. The pond in the foreground has lily pads and reeds. The sky is clear and blue.

SUN PROTECTION MODERN AND FLEXIBLE

MEETS LIGHT AND SHADOW

Glare-free daylight to be adjusted individually,
almost infinitely variable to your liking.
The reflexion of the sunlight generates a pleasant
indoor climate.
Visual protection for more privacy with adjustable
transparency towards the outside.



INSECTS KEPT OUT

EVEN WITH OPEN WINDOW

Our insect repelling gauze can be integrated into all ALUKON built-on and plastered systems. During summer time it protects from annoying insects and during winter it disappears invisibly and space-saving in the box.

INTEGRATED INSECT REPELLING SYSTEM

FOR MORE LIVING QUALITY

Optionally, the gauze fixed on a spring mechanism is integrated invisibly in the box behind the curtain.

It can be operated like a roller blind, pulled down and clicked into place via the Easy-Click-mechanism. During the winter half year it can be kept invisibly and rolled up in the box.

The gauze is made of robust fabric available in black or grey.



EASE OF USE

THE MOST SUITABLE FOR EVERY APPLICATION

It doesn't matter whether the motorization had been planned at the new building or has to be done later at a modernization, with modern remote control motors all functions are on hand and let you control individual roller shutters or groups of roller shutters from your sofa or office desk. With automatic controls the roller shutter and sun protection equipment open and close completely automatically – also during your absence from home.

Remote control operation

radio controlled drives with hand-held transmitter or time switch offer extra convenience



Automatization

sun protection equipment are Smart Home compatible and can be integrated in existing home controls







MOTOR DRIVES

AN EXTRA COMFORT FOR YOU

All venetian blind system are always equipped with comfortable electric drives. Venetian blind systems which shall be installed in places without electrical connection, can also be equipped with bevel gears.

ABSTRACT

VENETIAN BLIND SLATS

slats	F 80 Flat slats	C 80 flanged slats	CV 80 flanged slats	Z 80 Z-shaped, flanged slats	LS 80 Light guiding slats
					
Technical data for RAFF-E					
max. width	400 cm	-	400 cm	400 cm	400 cm
max. height	450 cm	-	405 cm	373 cm	393 cm
Technical data for facade venetian blinds					
max. width	500 cm	400 cm	500 cm	400 cm	400 cm
max. height	450 cm	450 cm	450 cm	450 cm	450 cm
Technical data for external venetian blinds					
max. width	360 cm	-	360 cm	360 cm	360 cm
max. height	366 cm	-	225 cm	200 cm	215 cm
Technical data for AK-FLEX.2					
max. width	500 cm	-	500 cm	400 cm	400 cm
max. height	450 cm	-	300 cm	260 cm	260 cm
Technical data for AK-MIRO PLUS					
max. width	335 cm	-	335 cm	335 cm	335 cm
max. height	450 cm	-	300 cm	260 cm	260 cm
Slat colours					
	RAL 7016 anthracite grey				
	RAL 7021 black grey				
	RAL 7035 light grey				
	RAL 7038 agate grey				
	RAL 8019 grey-brown				
	RAL 9001 cream white				
	RAL 9006 white aluminium				
	RAL 9007 grey aluminium				
	RAL 9016 traffic white				
	DB 703 iron-mica				

Subject to technical changes. No liability for printing errors. Colour deviations are printing related.

ABSTRACT

RAFF-E BOXES

RAFF-E box versions

Types of installation

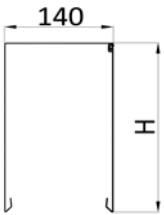
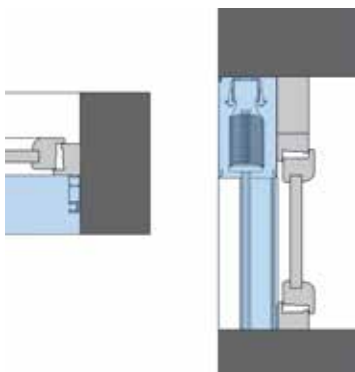
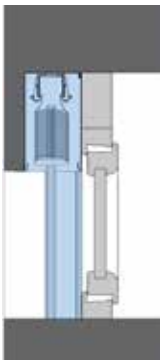
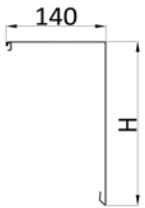
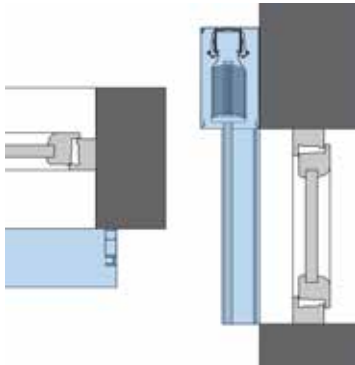
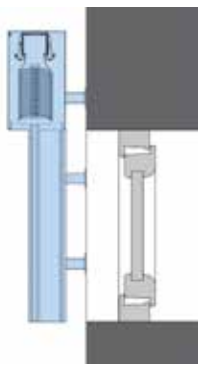
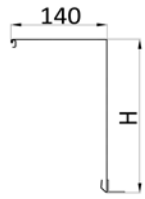
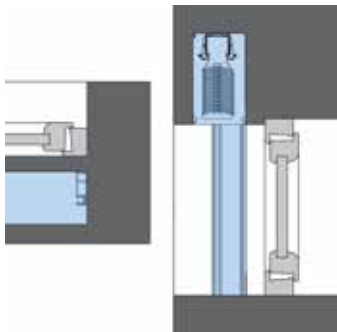
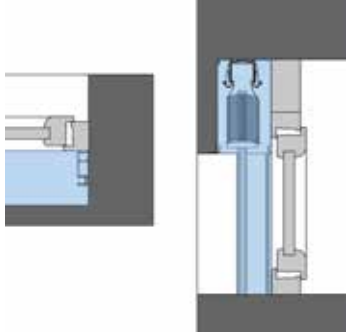



Box form	Box size	H	Colour		Variations	
			ALUKON RAL colour range	RAL (surcharge)		
 V1	200	200	•		 Visible box - installation in the lintel	 Plastered box - installation in the lintel
	240	240	•			
	300	300	•			
 V2	200	200	•		 At the facade	 In front of the facade with spacers
	240	240	•			
	300	300	•			
 V3 Plastered box	200	200	•		 As shaft installation	 As shaft installation with false edge
	240	240	•			
	300	300	•			

ABSTRACT

FACADE VENETIAN BLINDS

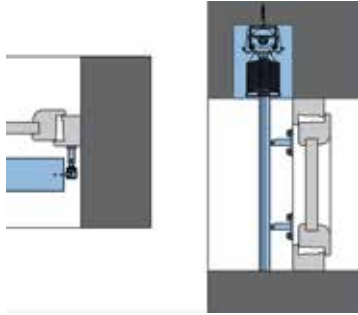
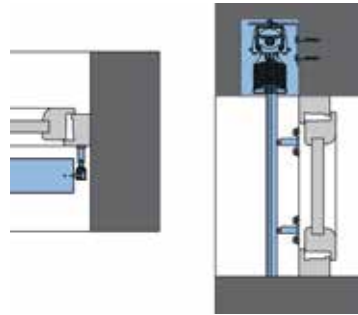
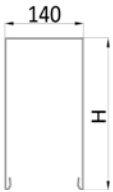
Exterior venetian blinds

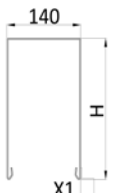
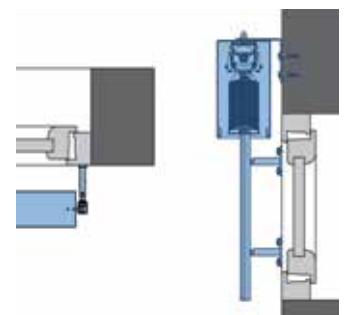
Types of installation

Form of blinds	Blind dimensions in mm	Colour		Variations	
	H	ALUKON RAL colour range	RAL (surcharge)		
Visible blinds					
 <p>L-blind</p>	180 200 220 240 260 280 300 320 340 360 380 400	•	•	 <p>S 01 Fixed up in the shaft with top bar support</p>	 <p>S 02 Fixed up in the shaft with angle</p>
 <p>U-blind</p>				 <p>L-blind</p>	•
 <p>U-blind brackets outside</p>	180 200 220 240 260 280 300 320 340 360 380 400	•	•	 <p>U 02 Fixed backwards by addendum angle</p>	
 <p>U-blind brackets inside and outside</p>				•	•

ABSTRACT

VENETIAN BLINDS BUILT-ON BOXES AND WINDOW FRAME MOUNTED BOXES

Built-on and plastered extruded boxes

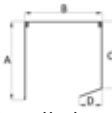
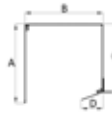
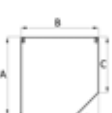
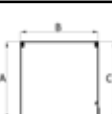
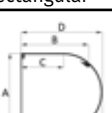
Box form	Box size	Box dimensions					Available box colours					
		A	B	C	D	E	standard colours					
							white 9016 m.	white SF*	silver anod.	brown SF	ALUKON RAL colour range	RAL (surcharge)
 20° bevelled, front access	165	168	168	145	48	-	•	•	•	•	•	•
	180	184	184	156	49	-	•	•	•	•	•	•
	205	210	210	179	74	-	•	•	•	•	•	•
 20° bevelled, bottom access*	165	168	168	145	46	-	•	•	•	•	•	•
	180	184	184	156	47	-	•	•	•	•	•	•
	205	210	210	179	71	-	•	•	•	•	•	•
 45° bevelled	165	169	169	121	47	-	•	•	•	•	•	•
	180	184	184	133	51	-	•	•	•	•	•	•
	205	209	209	151	74	-	•	•	•	•	•	•
 90° rectangular*	165	168	168	168	46	-					•	•
	180	184	184	184	47	-					•	•
	205	209	209	209	71	-					•	•
 round	165	169	146	92	176	54	•	•	•	•	•	•
	180	183	158	99	191	56	•	•	•	•	•	•
	205	210	183	113	219	84	•	•	•	•	•	•

*These colours do not correspond to a RAL shade.

Window frame mounted box

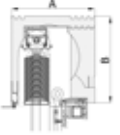
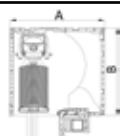

 AK-FLEX	265	265	260	-	-	-	Standard colour white					
	305	305	260	-	-	-	Other colours for guide rails and boxes (only AK-MIRO PLUS) to be found in the technical documentation of the window frame mounted systems as well as in the element price list.					
	365	365	260	-	-	-						
 AK-MIRO PLUS	240	240	255	-	-	-						

* with/without plaster angle
 Subject to technical changes. Colour deviations due to printing process.

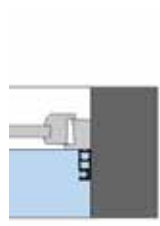

Types of installation

Variations

Built-on



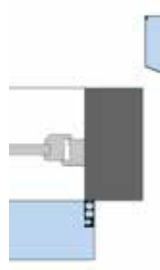

Installation in the lintel





Installation at the facade

Window frame mounted

AK-FLEX

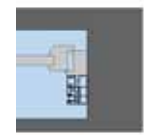
AK-MIRO PLUS

ALUKON COLOUR VARIETY

FOR ALL POWDER COATED ALUMINIUM PRODUCTS

ALUKON RAL colour range

brillant, matt or structured coating























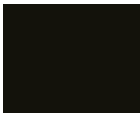
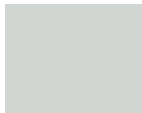





All other RAL colours, roll formed boxes, assembled components with roll formed boxes in RAL as well as extruded roller shutter profiles and curtains are excluded from this special colour range. For the corresponding prices and extra charges please refer to our catalogue or our price list for assembled components.

ALUKON standard colours
see price list for detailed information

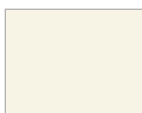
ALUKON RAL colour range
brillant, matt or structured coating

RAL Classic colour range K7
brilliant surface

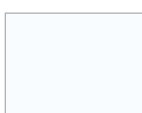
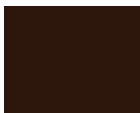
Special colours and supplier related colour shades
subject to availability

 RAL 1015 light ivory	 RAL 3004* purple red	 RAL 3005 wine red	 RAL 5011 steel blue	 RAL 6005* moss green
 RAL 6009* fir green	 RAL 7001 silver grey	 RAL 7004* signal grey	 RAL 7012* basalt grey	 RAL 7015 slate grey
 RAL 7016* charcoal	 RAL 7021 black grey	 RAL 7022 umbra grey	 RAL 7035* light grey	 RAL 7037 dusty grey
 RAL 7038 agate grey	 RAL 7039 black grey	 RAL 8001* ochre brown	 RAL 8003* clay brown	 RAL 8007 fawn brown
 RAL 8017* chocolate brown	 RAL 8019* grey brown	 RAL 8022 black brown	 RAL 9001 cream white	 RAL 9005 jet black
 RAL 9006 white aluminium	 RAL 9007 grey aluminium	 RAL 9010 pure white	 RAL 9016 traffic white	
 6768* brown matt and structured	 DB 703 iron mica matt and structured	* = highly weather proof coating for matt surfaces		

Surface types

All aluminium surfaces are durable, easy to clean and suitable for facades, with excellent weather proof and light resistance features. All products are coated with the latest technology in our modern powder coating facility to provide your favourite colours and surface type - Made in Germany.

ALUKON SUN PROTECTION, ROLLER SHUTTERS AND INSECT REPELLING SYSTEMS

QUALITY PRODUCTS MADE IN GERMANY

ALUKON is one of the leading German manufacturers of roller shutters, sun protection and insect repelling systems. We produce on two sites in Konradsreuth (Upper Franconia) and in Haigerloch (Swabia).

ALUKON products are developed with enthusiasm and innovative capacity out of high-grade and durable material made-to-measure both for modernization or for new buildings.

Find the right item for your needs in our huge variety of products and colors and choose from a wide range of additional equipment. We offer you individual complete solutions from a single source.

Privacy, indoor climate and mood of the light can be adapted individually with ALUKON products.

**More products and novelties are shown on our website
WWW.ALUKON.COM**

ALUKON KG KONRADSREUTH | Münchberger Straße 31 | D-95176 Konradsreuth | **Telephone:** +49 9292 950-0 | **Mail:** info@alukon.com
HAIGERLOCH | Am Griesbaum 1 | D-72401 Haigerloch | **Telephone:** +49 7474 3914-0 | **Mail:** info.haigerloch@alukon.com

Guidance, planning, sales and installation. All from one source.

ALUKON
Sonnenschutz Rollladen Insektenschutz